

# TD 200

## TEXT DISPLAY

FOR WORCESTER HEATING APPLIANCES  
WITH BUS-ENABLED HEATRONIC 3 AND RT 10

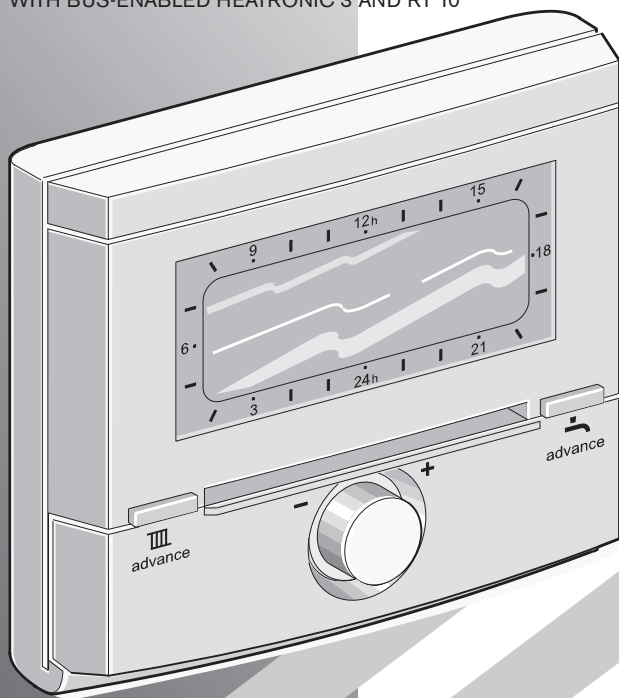

6 720 612 220-00 1R

INSTALLATION,  
USER INSTRUCTIONS &  
CUSTOMER CARE GUIDE

---

**Dear customer,**

Congratulations on having decided in favour of a top-quality product from our company.

The **TD 200** offers everything you can expect from a modern heating control: It is both reliable and energy saving.

Like all Bosch Group products, the **TD 200** has been produced and tested according to the most stringent quality standards so that you can enjoy the **WORCESTER** warmth for a long time to come.

# Contents

<b>1</b>	<b>Technical data for the accessory item</b>	<b>5</b>	5.6	General Settings	23
1.1	Standard package	5	5.6.1	Time and Date	23
1.2	Technical data	5	5.6.2	Display format	23
1.3	Accessories	5	5.6.3	Key lock	23
<hr/>					
<b>2</b>	<b>Regulations</b>	<b>6</b>	<b>6</b>	<b>INFO</b>	<b>24</b>
<hr/>					
<b>3</b>	<b>Installation</b>	<b>7</b>	<b>7</b>	<b>EXPERT SETTINGS</b>	<b>25</b>
3.1	Installation	7	7.1	EXPERT SETTINGS-Overview	25
3.2	Electrical connections	10	7.2	Operating instructions in brief	25
<hr/>					
<b>4</b>	<b>Operation</b>	<b>11</b>	7.3	System errors	25
4.1	Operating elements and symbols	11	7.4	Maintenance	25
4.2	Change room temperature and operating mode	13	7.5	Service address	25
4.2.1	Set room temperature time restricted	13	7.6	System info	26
4.2.2	Advance the next switching time and associated operating mode to the current time	13	<hr/>		
4.2.3	Changing the operating mode	14	<b>8</b>	<b>Service display</b>	<b>26</b>
4.3	Use menu	15	<hr/>		
4.3.1	Program	15	<b>9</b>	<b>General information</b>	<b>27</b>
4.3.2	Delete settings	17	<hr/>		
4.3.3	Reset factory settings	17	<b>10</b>	<b>Troubleshooting</b>	<b>28</b>
<hr/>					
<b>5</b>	<b>MAIN MENU</b>	<b>18</b>	<b>11</b>	<b>Settings</b>	<b>30</b>
5.1	MAIN MENU-Overview	18	11.1	MAIN MENU-Settings	30
5.2	Operating instructions in brief	19	11.2	EXPERT SETTINGS-Settings	31
5.3	Holiday	19	11.3	Time Programs	32
5.4	Heating	20	11.3.1	Heating Program	32
5.4.1	Program	20	11.3.2	Domestic Hot Water Program	33
5.4.2	Heating levels	21	<hr/>		
5.4.3	Optimum Start	21	<b>Index</b>	<b>34</b>	
5.5	Domestic Hot Water	22			
5.5.1	Program	22			
5.5.2	Circ. pump runs	22			

### Safety precautions

- ▶ These instructions must be observed to ensure correct operation.
- ▶ Only have the accessories installed by an authorised heating installer.
- ▶ Only use these accessories in conjunction with the heating appliances listed. Observe connection diagram!
- ▶ Never connect this accessory item to the 230 V mains electricity supply.
- ▶ Before assembling these accessories: Interrupt voltage supply (230 V AC) to the heating appliance and all additional devices using the bus.
- ▶ For wall mounting: Do not mount these accessories in wet rooms.

### Symbols



**Safety instructions** in this document are identified by a warning-triangle symbol and are printed on a grey background.

Signal words indicate the seriousness of the hazard in terms of the consequences of not following the safety instructions.

- **Caution** indicates that minor damage to property could result.
- **Warning** indicates that minor personal injury or serious damage to property could result.
- **Danger** indicates that serious personal injury could result. In particularly serious cases, lives could be at risk.



**Notes** are identified by the symbol shown on the left. They are bordered by horizontal lines above and below the text.

Notes contain important information in cases where there is no risk of personal injury or damage to property.

# 1 Technical data for the accessory item



The TD 200 can only be connected to a heating appliance with bus-enabled Heatronic 3 circuit board.

- The TD 200 serves to display boiler and system information and for changing the displayed values. If the Service button is pressed on the boiler, the TD 200 serves purely as a display for the Service mode.
- The TD 200 is a timer with time programs for:
  - Heating : 7 day heating program with 6 switching times per day
  - Hot water : 7 day hot water program with 6 switching times per day
- Room temperature control of an unmixed heating circuit is possible in conjunction with the RT 10. The TD 200 receives the **current room temperature** via the temperature sensor integrated in the RT 10.
- If no RT 10 is connected, the TD 200 works purely as a timer with On/Off function for the time program without consideration of the room temperature.
- The TD 200 has a battery power reserve of approx. 20 months. If the TD 200 has not received any power for longer than 20 months, the time and date are deleted. All other settings are maintained.
- Installation options:
  - In the heating appliance with bus-enabled Heatronic 3
  - With optional accessory:  
Wall mounting with bus connection to the heating appliance with bus-enabled Heatronic 3

## 1.1 Standard package

TD 200 without wall mounting socket for installation in the heating appliance.

## 1.2 Technical data

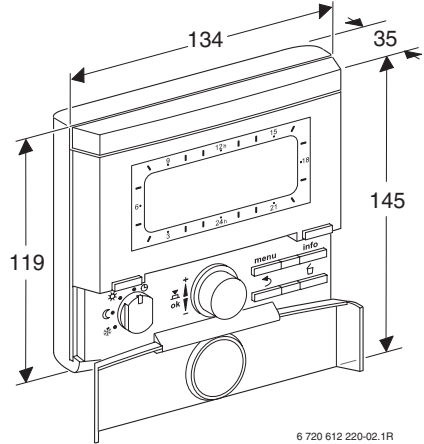

Fig. 1 Unit dimensions with base (accessory)

<b>Nominal voltage</b>	10...24 V DC
<b>Bus supply</b>	15 V DC
<b>Nominal current</b> (without lighting)	6 mA
<b>Controller output</b>	2-wire bus
<b>Permissible ambient temperature</b>	0 ... +50 °C
<b>Class of protection</b>	III
<b>Type of protection:</b> - Installed in Heatronic 3 - Wall mounting	IPX2D IP20
	CE

## 1.3 Accessories

- Base for wall mounting
- Room temperature controller RT 10 .

# 2 Regulations

### **Related standards:**

- BS EN60730-1:2001
- BS EN60730-2-7:1992
- Electro Magnetic Compatibility and Radio Spectrum Matters (ERM); Short Range Devices (SRD) ETSI
- EN300 220 1.

### **EC Directives:**

- European Union Law Directive 2000/R4/EC
- Low Voltage Directive (73/23/EEC)
- Electro Magnetic Compatibility Directive (89/336/EEC)
- CE Marking Directive (93/68/EEC).

### 3 Installation



**Danger:** risk of electric shock!

- ▶ Before assembling these accessories:  
Interrupt voltage supply (230 V AC) to the heating appliance and all additional devices using the bus.

#### 3.1 Installation

##### Installation of the TD 200 in heating appliance with bus-enabled Heatronic 3

- ▶ For a detailed description of the heating appliance parts, see installation instructions of the heating device.

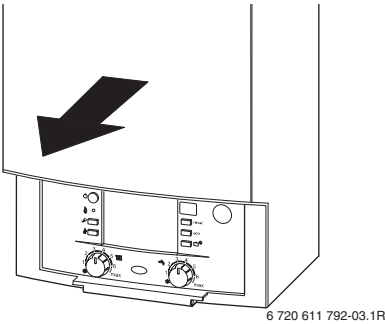

Fig. 2 Remove the outer casing

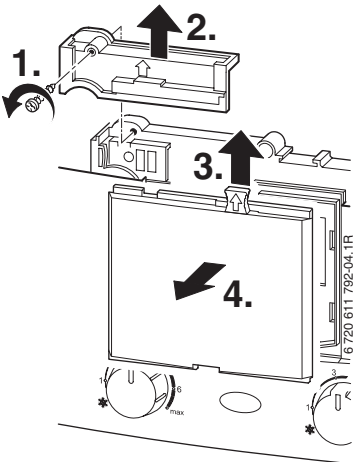

Fig. 3 Remove cover and blanking plate

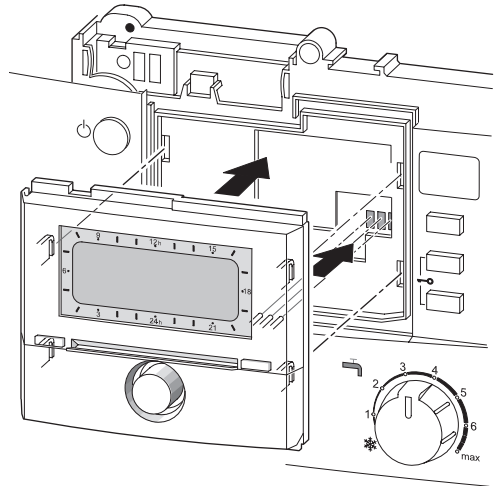

Fig. 4 Insert TD 200 in the guides

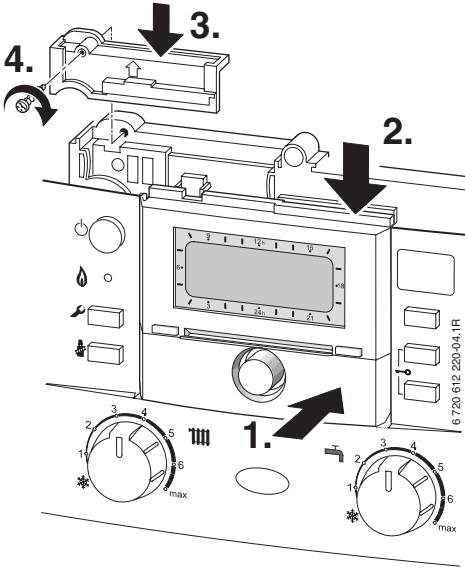

Fig. 5 Lock TD 200 into place and replace cover



### Installing the TD 200 on the wall

- ▶ Use the wall mounting socket accessory for wall mounting.

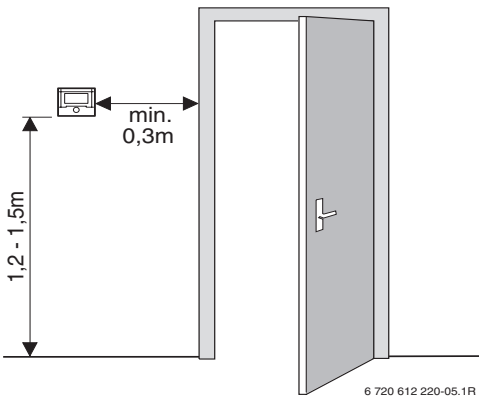

Fig. 6 Select mounting location

- ▶ Make electrical connections (see Figure 10).

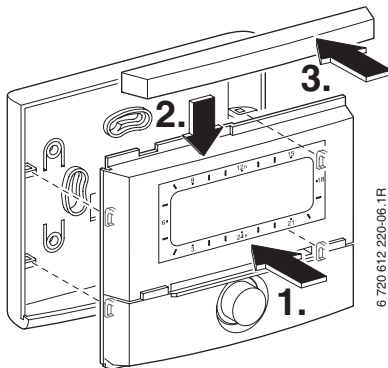

Fig. 8 Locate TD 200 upper part and slide into frame



The mounting surface on the wall must be even.

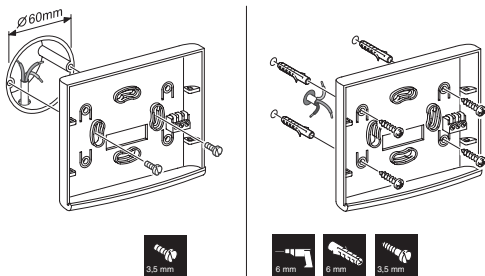

Fig. 7 Wall mounting socket accessory

### 3.2 Electrical connections

#### TD 200 in the heating appliance with bus-enabled Heatronic 3 circuit board

- ▶ Installation of the TD 200 automatically creates the bus connection via the three contacts (Figure 4).

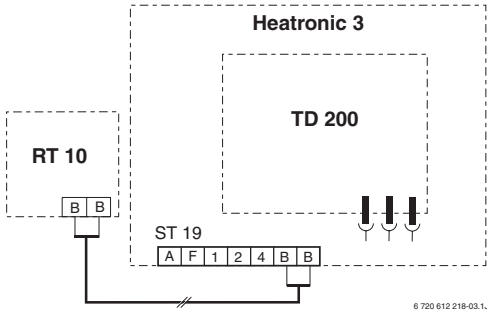

Fig. 9 TD 200 integrated in the bus-enabled Heatronic 3.

#### TD 200 on the wall

- ▶ Bus connection from the TD 200 to additional devices using in the bus (e. g. RT 10): Use electrical cables corresponding to type H05 VV-... (NYM-1...) minimum.

Permissible cable lengths of the bus-enabled Heatronic 3 to the TD 200:

Cable length	Cross section
≤ 80 m	0.40 mm <sup>2</sup>
≤ 100 m	0.50 mm <sup>2</sup>
≤ 150 m	0.75 mm <sup>2</sup>
≤ 200 m	1.00 mm <sup>2</sup>
≤ 300 m	1.50 mm <sup>2</sup>

- ▶ To avoid inductive influences, lay all cables carrying low voltage lines of 230 V or 400 V separately (minimum spacing 100 mm).
- ▶ Shield the cables in the case of external inductive influences. This ensures that the cables are shielded against external influences (e.g. heavy current cables, overhead contact wires, transformer

stations, radio and television appliances, amateur radio stations, microwave appliances etc).

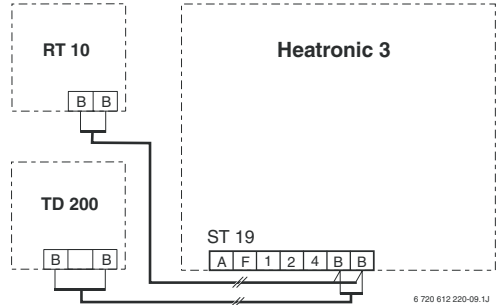

Fig. 10 TD 200 connected to the bus-enabled Heatronic 3.



If the cable cross sections of the bus connections from the TD 200 and from the RT 10 to the bus-enabled Heatronic 3 are different:

- ▶ Connect bus connections via a junction box.

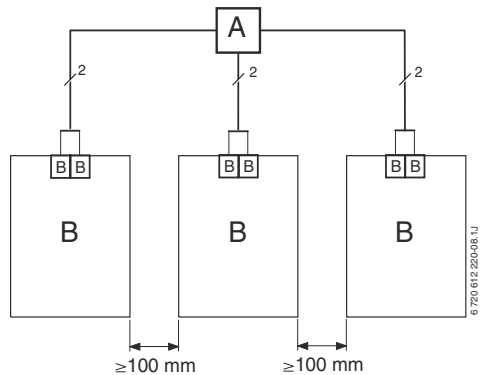

Fig. 11 Connection of the bus connections via junction box (A)

## 4 Operation

### 4.1 Operating elements and symbols

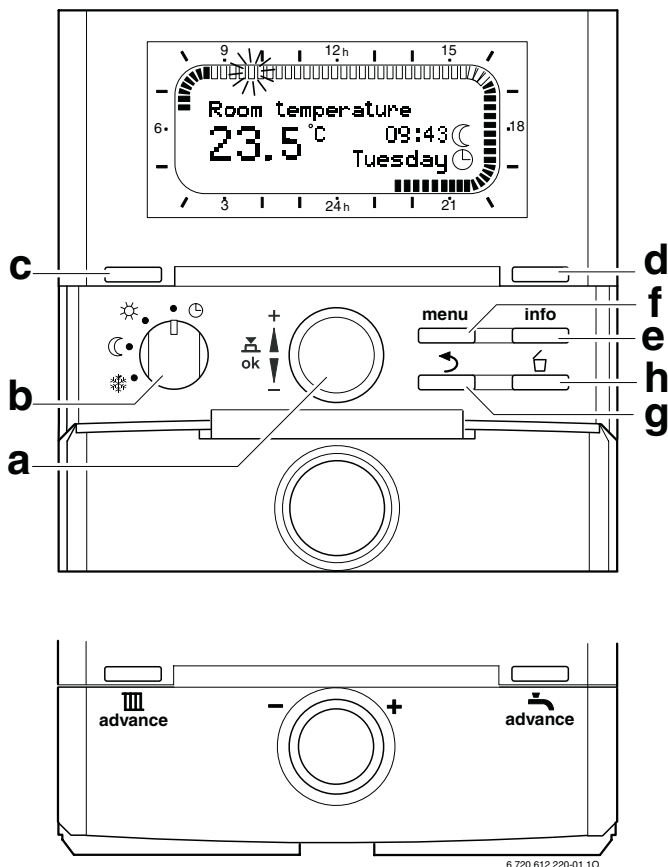
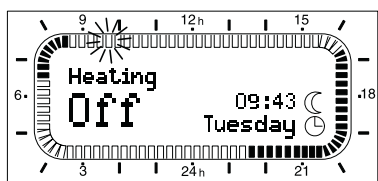

Fig. 12 Standard display when connected RT 10



If no RT 10 is connected, this standard display appears as follows:



6 720 612 220-16.J

Operating elements	
<b>a</b>	Turn selection knob  in the + direction: Select upper Menu/Info texts or set value higher
	Turn selection knob  in the - direction: Select bottom Menu/Info texts or set value lower
	Press selection knob  : Open or save Menu/value
<b>b</b>	Operating mode switch:
	<b>Heating</b> <b>Hot water</b>
	Automatic mode      Automatic mode
	Continuous <b>High or On</b> Continuous <b>On</b>
	Continuous <b>Low or Off</b> Automatic mode
Continuous <b>Frost</b> Continuous <b>Off</b>	
<b>c</b>	Button  : To advance the next switching time and the associated operating mode = <b>High or On</b> = <b>Low or Off</b> = <b>Frost</b> for the heating to the current time.
<b>d</b>	Button  : To advance the next switching time and the associated operating mode <b>On or Off</b> for hot water heating to the current time
<b>e</b>	Button  : Display values
<b>f</b>	Button  : Open Menu
<b>g</b>	Button  : Show previous menu level
<b>h</b>	Button  : Delete/Reset value

Symbols	
<b>23.5°C</b>	Current room temperature (only with RT 10)
	Flashing segment: current time from <b>09:30</b> until <b>09:45</b>
	Full segments: Heating program current day for = <b>High or On</b> (1 Segment = 15 min)
	Empty segments: Heating program current day for = <b>Low or Off</b> (1 Segment = 15 min)
	No segments: Heating program current day for = <b>Frost</b> (no segments)
	Operating mode <b>High or On</b> for heating
	Operating mode <b>Low or Off</b> for heating
	Operating mode <b>Frost or Off</b> for heating
	Automatic mode for heating
	Holiday program
	Burner on
<b>+</b>	Upper Menu/Info texts or value higher
<b>-</b>	Bottom Menu/Info texts or value lower
<b>ok</b>	Open or save Menu/value
	Call up parent menu level
	Delete/Reset value
	Advance next switching time and the associated operating mode = <b>High or On</b> = <b>Low or Off</b> = <b>Frost</b> for the heating to the current time.
	Advance next switching time and the associated operating mode <b>On</b> or <b>Off</b> for hot water heating to the current time.



In order to simplify this document, the operating elements and operating modes will sometimes only be identified by symbols, e.g. or .

## 4.2 Change room temperature and operating mode

### 4.2.1 Set room temperature time restricted

To permanently change the room temperature, see Chapter 5.4.2 on page 21.

Without the RT 10 this function is not available.

If an RT 10 is connected and the standard display is displayed in Automatic mode ☺:

- ▶ Set required room temperature with . The temperature setting is effective until the next switching time. After this the room temperature set for the heating program is valid.

### 4.2.2 Advance the next switching time and associated operating mode to the current time

To permanently change the operating mode, see Chapter 4.2.3 on page 14.

To cancel **Heating Advance on**:

- ▶ Press  again.

### Hot Water Advance

If the standard display is displayed in Automatic mode ☺ or continuous economy ☾ is displayed:

- ▶ Press  to advance the next switching time and associated operating mode **On** or **Off** for hot water heating to the current time. The display shows **Hot Water Advance on** and the altered data.

If the next switching time of the hot water program is exceeded, **Hot Water Advance on** is reset and Automatic mode is active again.

**Hot Water Advance on** Cancel in advance:

- ▶ Press  again.



Use the function if there is no longer a demand for heat or if the home is to be left for a longer period or if an unexpected return to the property occurs.

## Heating Advance

If the standard display is displayed in Automatic mode ☺:

- ▶ Press  to advance the next switching time and associated operating mode

☼ = **High** or **On**

☾ = **Low** or **Off**

❄ = **Frost**

for the heating to the current time.

The display shows **Heating Advance on** and the altered data.

If the next switching time of the heating program is exceeded, **Heating Advance on** is reset and Automatic mode is active again.

### 4.2.3 Changing the operating mode



#### Automatic mode (default setting)

- **Heating with RT 10:**  
Automatic change between **High** ☀ / **Low** ☾ / **Frost** ❄ corresponding to the heating program. The TD 200 controls the room temperatures set in the submenu **Heating levels** (see Chapter 5.4.2 on page 21).
- **Heating without RT 10:**  
Automatic change between **On** ☀ / **Off** ☾ corresponding to the heating program. During **On** ☀ the flow temperature set on the heating appliance is controlled.
- **Hot water:**  
Automatic change **On** / **Off** corresponding to the hot water program entered.



#### Continuous heating

- **Heating with RT 10:**  
The TD 200 continuously controls to the room temperature set in the submenu **Heating levels** for **High** ☀ (see Chapter 5.4.2 on page 21). The heating program is ignored.
- **Heating without RT 10:**  
A continuous control to the flow temperature set on the heating appliance is performed. The heating program is ignored.
- **Hot water with combination heating appliance:**  
If the ECO button is not pressed on the heating appliance, hot water is immediately available. The hot water program is ignored.
- **Domestic hot water storage tank:**  
Hot water is continuously controlled to the hot water temperature set on the heating appliance. The hot water program is ignored.



#### Continuous low mode

- **Heating with RT 10:**  
The TD 200 continuously controls to the room temperature set in the submenu **Heating levels** for **Low** ☾ (see Chapter 5.4.2 on page 21). The heating program is ignored.
- **Heating without RT 10:**  
A continuous control to the flow temperature which corresponds to the heating appliance frost protection is performed. The heating program setting is ignored. The heating remains switched off apart from the heating appliance frost protection
- **Hot water:**  
Automatic change **On** / **Off** corresponding to the hot water program entered.



#### Continuous frost protection

- **Heating with RT 10:**  
The TD 200 continuously controls to the room temperature set in the submenu **Heating levels** for **Frost** ❄ (see Chapter 5.4.2 on page 21). The heating program is ignored.
- **Heating without RT 10:**  
A continuous control to the flow temperature which corresponds to the heating appliance frost protection is performed. The heating remains switched off apart from the heating appliance frost protection. The heating program is ignored.
- **Hot water with combination heating appliance:**  
Hot water is immediately available. The hot water program is ignored.
- **Domestic hot water storage tank:**  
The hot water can cool down to 10°C. The hot water program is ignored.

## 4.3 Use menu

### 4.3.1 Program



The programming steps are always carried out according to the same principle. The functions of the operating elements and the meaning of the symbols are described in Chapter 4.1 from page 11, e.g. to enter a heating program, perform the following programming steps (example with RT 10 present).

#### Call up Main Menu

- ▶ Press button . The display lights up and the Main Menu is shown.

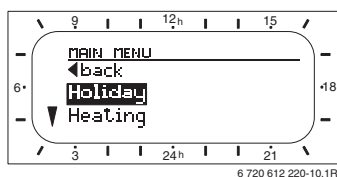



Fig. 13 Main Menu

#### Select submenu

- ▶ Turn selection knob  until the the required menu item is highlighted. In the example: Select **Heating**.
- ▶ Press selection knob  to confirm the selection. The submenu is displayed.

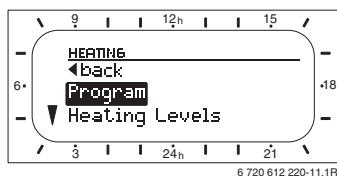



Fig. 14 Submenu: Heating

- ▶ Turn selection knob  until the the required menu item is highlighted. In the example: Select **Program**.
- ▶ Press selection knob  to confirm the selection. The next submenu is displayed.



The segments for the heating program are only displayed if all switching times for **Mo - Fr** are the same.

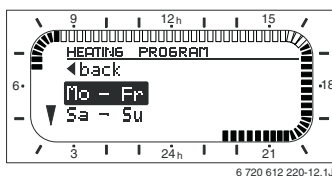



Fig. 15 Submenu: Heating Program

- ▶ Turn selection knob  until the the required menu item is highlighted. In the example: Select **Mo - Fr**.
- ▶ Press selection knob  to confirm the selection. The next submenu with the pre-programmed switching times and operating modes **P1** to **P6** is displayed.

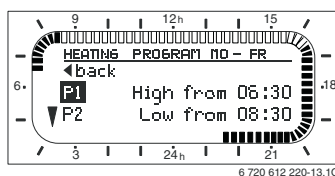

Fig. 16 Submenu: Heating Program Mo - Fr

## Set values

- ▶ Turn selection knob until the the required menu item is highlighted.  
In the example: Select **P1**.
- ▶ Press selection knob to confirm the selection.  
The switching time to be changed and the associated segment flashes.

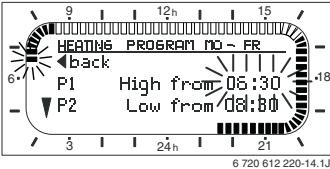

Fig. 17 Submenu: Heating Program Mo - Fr

- ▶ Turn selection knob to set the switching time.  
In the example: Set **05:30**.  
The associated segments change at the same time.
- ▶ Press selection knob to save the switching time.  
The switching time saved is also accepted for the individual days **Monday to Friday**.  
The operating mode to be changed and the segment of the new switching time flashes.

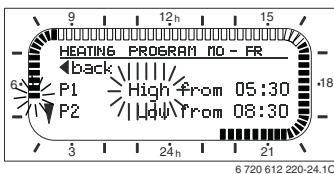

Fig. 18 Submenu: Heating Program Mo - Fr

- ▶ Turn selection knob to set the operating mode.  
In the example: Set **Low**.

- ▶ Press selection knob to save the operating mode.  
The operating mode saved is also accepted for the individual days **Monday to Friday**.  
The setting for **P1** is now complete. The altered switching time, operating mode and segments are displayed.

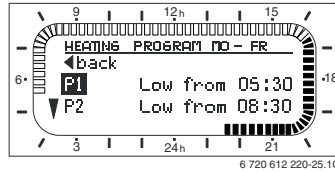

Fig. 19 Submenu: Heating Program Mo - Fr

- ▶ Set further switching times and operating modes **P2 to P6** as described above.
- or-
- ▶ Select menu level:
  - Push button or
  - Turn selection knob until the menu item **back** is highlighted and press the selection button to confirm the selection.  
The parent menu is displayed.

## End programming

- ▶ Press the button.



This process can be repeated for Saturday and Sunday programming and individual days.



### 4.3.2 Delete settings

Either overwrite the value for delete it using the button .

- ▶ Select the value to be deleted in the Menu. In the example: Select **P1**.
- ▶ Press the  button. The deleted value flashes.

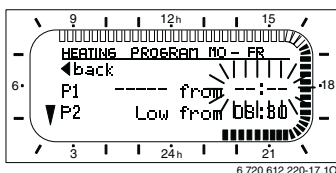







Fig. 20 Submenu: P1 deleted

- ▶ Press the selection knob  to save the switching time.
- ▶ Press the  button to return to the standard display.

### 4.3.3 Reset factory settings

#### Reset a program

Example for resetting a heating program:

- ▶ Select the menu **Heating > Program > Reset to factory**.
- ▶ Press the selection knob  to confirm the selection.
- ▶ Turn the selection knob  to set **Yes**.
- ▶ Press the selection knob  to save the setting. In the example **Heating Program** appears when resetting this help text:

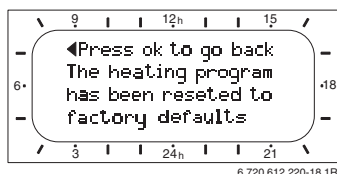



Fig. 21 Help text: Reset to factory

- ▶ Press the selection knob  to return to the Menu.

### Reset all settings



All personal settings are reset to the default settings with this function.

If the standard display is set:

- ▶ Keep  and  pressed at the same time until the following warning text is displayed:

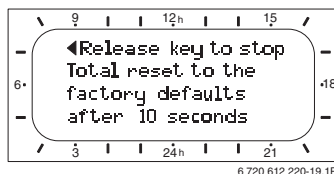



Fig. 22 Warning text: Total reset

- ▶ If you wish to perform the total reset:  Continue to keep  pressed at the same time until the following help text is displayed:

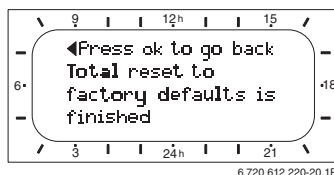



Fig. 23 Help text: Total reset

All personal settings have been reset to the factory setting.

- ▶ Press the selection knob  to return to the standard display.

## 5 MAIN MENU

### 5.1 MAIN MENU-Overview

MAIN MENU	Submenu			Description Page
	1.	2.	3.	
	◀ back			
Holiday	◀ back			19
	Start	-	-	
	End	-	-	
	Heating level	-	-	
	Domest. hot water	-	-	
Heating	◀ back			20
	Program	◀ back		
		Mo - Fr	◀ back	
			P1, P2 ... P6	
		Sa - Su	◀ back	
			P1, P2 ... P6	
		All days	◀ back	
			P1, P2 ... P6	
	Monday, Tuesday ... Sunday	◀ back		
		P1, P2 ... P6		
	Reset to factory	-		
	Heating levels <sup>1)</sup>	◀ back		
		High	-	
		Low	-	
Frost		-		
Optimum Start <sup>1)</sup>	-	-		
Domestic Hot Water	◀ back			22
	Program	◀ back		
		Mo - Fr	◀ back	
			P1, P2 ... P6	
		Sa - Su	◀ back	
			P1, P2 ... P6	
		All days	◀ back	
			P1, P2 ... P6	
	Monday, Tuesday ... Sunday	◀ back		
		P1, P2 ... P6		
Reset to factory	-			
Circ. pump runs	-	-		
General Settings	◀ back			23
	Time and Date	◀ back		
		Time	-	
		Date	-	
		Summer-/Wintertime	-	
		Time adjustment	-	
	Display format	◀ back		
		Time	-	
		Date	-	
		Temperature	-	
		LCD contrast	-	
Key lock	-	-		

1) Heating with RT 10



Factory settings, setting range and personal settings:  
Chapter 11 from page 30.

## 5.2 Operating instructions in brief

 : **MAIN MENU** open/close

 : Select submenu/Set value

 : Open submenu/Save value

 or **back**: Call up parent menu level

Navigation in the menu structure, programming, deleting values and resetting back to the factory settings are described in detail in Chapter 4.3 on page 15.

## 5.3 Holiday

The Holiday program controls the heating and hot water heating for the operating mode set in the holiday program (frost protection is ensured).

- **Holiday > Start:**
  - If the date for **Start** is today, the Holiday program starts immediately.
  - If the date for **Start** is from tomorrow or later, the Holiday program starts at **00:00** (= **12:00 am**) on the day set.
- **Holiday > End:**  
The Holiday program ends at **23:59** (= **11:59 pm**) on the day set
- **Holiday > Heating level:**  
Operating mode for the heating during the Holiday program
- **Holiday > Domest. hot water:**  
Operating mode for the hot water during the Holiday program.

If the Holiday program is active, the following will appear for example:

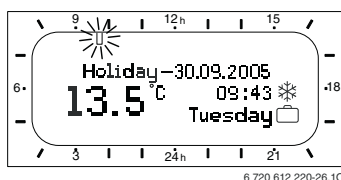



Fig. 24 Holiday active

Cancel Holiday mode in advance:

- ▶ Select Menu **Holiday > Start** and press .  
The display shows **---:---:---**.
- ▶ Press the selection knob  to save the setting.

## 5.4 Heating

---



Set the flow temperature controller on the heating appliance to the maximum inlet temperature required.

---

### 5.4.1 Program

#### Default setting (Automatic mode)

#### Heating with RT 10:

- Automatic change between **High** ☀ / **Low** ☾ / **Frost** ❄ corresponding to the heating program entered.
- Operating mode **High** ☀:  
The TD 200 controls to the room temperature set for the the operating mode **High**.
- Operating mode **Low** ☾:  
The TD 200 controls to the room temperature set for the the operating mode **Low**.
- Operating mode **Frost** ❄:  
The TD 200 controls to the room temperature set for the the operating mode **Frost**.

#### Heating without RT 10:

- Automatic change between heating **On** ☀ / **Off** ☾ corresponding to the heating program entered.
- Operating mode **On** ☀:  
The heating appliance controls to the flow temperature set.
- Operating mode **Off** ☾:  
The heating appliance controls to the flow temperature which corresponds to the heating appliance frost protection.

#### Setting options

- **Heating with RT 10:** Maximum six switching times per day with three different operating modes (**High** / **Low** / **Frost**).
- **Heating without RT 10:** Maximum six switching times per day with two different operating modes (**On** / **Off**).
- optionally the same times for each day, Monday - Friday, Saturday - Sunday or different times for each day
- optionally different times for each day or the same times for:
  - Each day (**All days**)
  - Monday to Friday (**Mo - Fr**)
  - Saturday and Sunday (**Sa - Su**)
- shortest switching period is 15 minutes (= 1 Segment).

#### Set switching times and operating mode

---



Deactivate unrequired switching times by deleting them.

---

- **Mo - Fr:** Begin Monday to Friday at the same time with the selected operating mode.
- **Sa - Sun:** Begin Saturday and Sunday at the same time with the selected operating mode.
- **All days:** Begin each day at the same time with the selected operating mode.
- individual week day (e.g. **Thursday**): Begin each Thursday at the same time with the selected operating mode.
- **Reset to factory:** Reset switching times and operating modes, see Chapter 4.3.3 on page 17.



If the programming for e.g. **Thursday** differs from the remaining week days, the selection will display **All days** and **Mo - Fr** for all values ----- **from** --:--. i.e. there are no joint switching times and operating modes for this selection.

If the switching times and operating modes are not to be changed, skip this with  $\frac{\Delta}{ok}$  or  $\uparrow$ .

## 5.4.2 Heating levels

**Heating levels** is only available if a RT 10 is connected.

For each operating mode (**High / Low / Frost**) the required room temperature can be set here.

## 5.4.3 Optimum Start

**Optimum Start** is only available if a RT 10 is connected and the heating program is in Automatic mode. This function can be switched on and off at the TD 200.

**Optimum Start** delays the heating start after low phase.

To enable the required room temperature to be attained approx. 1 hour after the programmed switching time **High**  $\star$ , the TD 200 calculates the optimum time point for the heating start.

Example:

- required room temperature: 21 °C
- current room temperature: 16 °C
- Factor for room heating: 1 K in 10 minutes.

To reach the required room temperature, the heating requires 50 minutes on account of the 5 K difference. It is therefore only 10 minutes after the programmed switching time **High**  $\star$  that the heating starts.

## 5.5 Domestic Hot Water

- ▶ Set the required hot water temperature on the heating appliance.  
The heating appliance ensures frost protection.

For a hot water storage tank with its own temperature control:

- ▶ Set the required hot water temperature at the hot water storage tank.  
Frost protection is only ensured during the operating mode hot water **On**.

### 5.5.1 Program

- Automatic change between hot water **On** / **Off** corresponding to the hot water program entered.
- **On**: The heating appliance controls to the hot water temperature set.
  - For a combination appliance: If the ECO button is not pressed on the heating appliance, hot water is immediately available.
  - For a heating system with hot water storage tank: Depending on the tank size and the hot water consumption, one tank filling per day is often sufficient (e.g. before the first or after the last heating phase of the day).
- **Off**: The heating appliance controls to approx. 10°C water temperature which corresponds to the heating appliance frost protection.
  - For a combination appliance: The heat exchanger inside the heating appliance does not remain heated, as a result hot water is not available until after a longer period of drawing off the hot water.
  - For a heating system with hot water storage tank: After a successful tank filling during hot water **On**, hot water remains available to a limited degree.

### Setting options

- Maximum six switching times per day with two different operating modes (**On** / **Off**).
- optionally the same times for each day or different times for each day
- shortest switching period is 15 minutes (= 1 segment).

### Set switching times and operating mode

---



Deactivate unrequired switching times by deleting them.

---

Week days, switching times and associated operating modes (**On** / **Off**), as described in detail in Chapter 5.4 on page 20.

### 5.5.2 Circ. pump runs

---



If no circulation pump is present, the setting in the Menu **Circ. pump runs** has no effect.

---

This function defines the number of circulation pump starts per hour during the hot water **On** phase. With the setting:

- 0/h the circulation pump always remains inactive.
- 1/h to 6/h the circulation pump remains in operation at each start for 3 minutes.
- 7/h the circulation pump operates continuously during the hot water **On** phase.

During the hot water **Off** phases the circulation pump remains inactive.

## 5.6 General Settings

### 5.6.1 Time and Date

#### Time / Date

**Time** and **Date** are already set ex works.

If the power supply for the TD 200 is interrupted for longer than 20 months, the time and date can be reset here.



The current day of the week (e.g. **Mo**) is automatically calculated via the date.

#### Summer-/Wintertime

The automatic summer/winter time setting can be switched on or off.

#### Time adjustment

A corrective factor can be set for the time here. This corrective factor is applied once per week.

Ascertain corrective factor, example:

- The time deviates by approx. -3 minutes in the course of a year.
- -3 minutes in the year correspond to -180 seconds in the year
- 1 year has 52 weeks
- -180 seconds: 52 weeks  
= -3.46 seconds per week.

The requisite corrective factor is

**+3.5 s/week.**

### 5.6.2 Display format

#### Time

The format for the time display can be selected between **12h am/pm** or **24h** here.

#### Date

The format for the date display can be selected between **MM.DD.YYYY** or **DD.MM.YYYY** here (D = Day, M = Month, Y = Year).

#### Temperature

The format for the temperature display can be selected between **°C** or **°F** here.

#### LCD contrast

The contrast for the display can be set between **25%** and **75%**.

### 5.6.3 Key lock

The key functions can be locked against inadvertent or unauthorised activation.

If **Key Lock** is active and a locked key is pressed during the standard display, the following will appear:

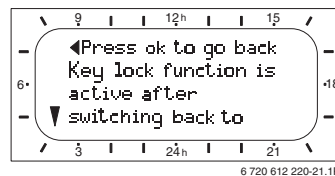

Fig. 25 Help text: Key lock active



The settings changed will only become active after deactivating the **Key Lock**.

Deactivate the lock for the key functions:

- ▶ Keep  and  pressed at the same time until the standard display appears.

## 6 INFO

Various system information messages can be displayed here.

### Operating instructions in brief

 : **INFO** open/close

 : Open submenu:

 : Select submenu/info texts

 or **◀ back**: Call up parent menu level

INFO	Display text	Description
	◀ back	
Boiler Information	◀ back	
	Burner On / Off	Indicates whether the burner is switched on or off
	Pump On / Off	Indicates whether the pump in the heating appliance is switched on or off
	Max. flow temperature 75.0°C	Maximum flow temperature set at the heating appliance
	Max. domestic hot water temperature 60.0°C	Maximum hot water temperature set at the heating appliance
System Information	◀ back	
	RT 10 connected Yes / No	Indicates whether a RT 10 is present
	Optimum start On / Off	Indicates whether Optimum Start is switched on or off (only with RT 10)
	Operation Mode Auto-high / Auto-low / Auto-frost / Auto-on / Auto-off / High / Low / Frost / On / Off / Holiday-high / Holiday-low / Holiday-frost / Holiday-on / Holiday-off	Current operating mode or special mode for the heating
	Requested room temperature 25.0°C	Room temperature requested by the RT 10 (only with RT 10)
	Actual room temperature 22.0°C	Room temperature measured at the RT 10 (only with RT 10)
	Requested flow temperature 75.0°C	Requested flow temperature
	Actual flow temperature 47.0°C	Flow temperature measured at the heating appliance
	Domestic Hot Water	◀ back
Operation mode Auto-on / Auto-off / On / Off / Holiday-on / Holiday-off		Current operating mode or special mode for the hot water
Requested domestic hot water temperature 60.0°C		Hot water temperature requested by the TD 200
Actual domestic hot water temperature 40.0°C		Hot water temperature measured at the heating appliance
Domestic hot water request status Active / Passive		State of the hot water heating
Service	◀ back	
	Worcester hotline Telephone number	Hotline telephone number of the heating appliance manufacturer
	Service telephone Telephone number	Service telephone number of the specialist heating company (system manufacturer)
	Service address Heating company Ltd.	Service address of the specialist heating company (system manufacturer)
	Instructions	◀ back
Set new...		Operating Instructions



## 7 EXPERT SETTINGS



The menu **EXPERT SETTINGS** is intended for the specialist / installer!

### 7.1 EXPERT SETTINGS-Overview

EXPERT SETTINGS	Submenu	Description Page
◀ back		
System errors	◀ back - -	25
Maintenance	◀ back Next maintenance Interval Confirm maintenance	
Service address	◀ back Telephone number Name	
System info	◀ back Installation date Type and number Software version Manufacturing date RT 10 equipped?	



Factory settings, setting range and settings for the expert: Chapter 11 from page 30

### 7.2 Operating instructions in brief

(press approx. 3 seconds):

**EXPERT SETTINGS** open

: **EXPERT SETTINGS** close

: Select submenu/Set value

: Open submenu/Save value

or **back**: Call up parent menu level

Navigation in the menu structure, programming, deleting values and resetting back to the factory settings are described in detail in Chapter 4.3 on page 15.

### 7.3 System errors

Fault history

The expert can have the last 10 faults which may have occurred displayed here (error date, code and description). The first fault displayed can still be active. The further faults are no longer active.

### 7.4 Maintenance

The expert can set and activate the interval for the requisite maintenance here.

**0 months** means that the function is not available.

### 7.5 Service address

In case of servicing the expert can enter the telephone number and address of the specialist company here.



Enter spaces:

- ▶ If the current character has a dark background, skip with .

### 7.6 System info

The expert can display various system information messages here:

- **Installation date** (automatically becomes active on commissioning)
- **Type number** (fixed value)
- **Software version** (fixed value)
- **Manufacturing date** (fixed value)
- **RT 10 equipped? Yes / No** (is automatically set on commissioning with RT 10 to **Yes**).



If the RT 10 is removed: Set

- ▶ **RT 10 equipped?** to **No**.

### 8 Service display

If the Service button is pressed on the heating appliance and the Service mode is active, the following display typically appears instead of the Service display:

#### **Service 1.A: set maximum central heating heatout**

No programming is possible when the Service mode is active. Only the operating mode can be changed via the operating mode switch.

## 9 General information

... Notes on saving energy:

- The temperature in the room where the RT 10 is installed acts as a guide parameter for the entire heating network. As a result, the power of the radiators must be set as low as possible, using thermostatic radiator valves.
- Control the temperature in the adjoining rooms via thermostatic radiator valves.
- Heat from other sources in the room (e.g. sunshine etc.) can lead to the heating in the adjoining rooms remaining too low.
- A significant amount of energy can be saved by lowering the room temperature. A reduction in temperature by 1 K (°C) can result in up to 5 % energy saving.
- Good thermal insulation of the building: The set low temperature level is not reached. Energy is therefore saved, as the heating remains switched off.
- Do not keep windows open on vent setting to ventilate. This would continuously cool down the room without significantly improving the air in the room.
- Ventilate fully for a short time (completely open windows).
- Turn the thermostatic valve during ventilation or switch to low setting.

## 10 Troubleshooting

Faults in the devices using the bus are displayed.

A fault in the heating appliance is shown in the display with corresponding help texts.

- Contact a heating expert.



For the expert:

- Rectify the fault in accordance with the heating appliance documentation.

Display	Cause	Remedy
<b>RT 10 defect</b>	Temperature sensor in the RT 10 defective	Emergency mode: The heating automatically goes into On / Off mode.
		If <b>Room temperature</b> continues to be displayed during the standard display: Set <b>RT 10 equipped?</b> to <b>No</b> (see System info on page 26).
		Have the bus connection checked and, if necessary, the interruption rectified by a professional.
		Have RT 10 replaced by a professional.
<b>No Bus communication</b>	The RT 10 using the bus no longer responds.	Have the bus connection checked and, if necessary, the interruption rectified by a professional.
	Heating appliance using the bus no longer responds.	Have the bus connection checked and, if necessary, the interruption rectified by a professional.
<b>On / Off</b> instead of <b>Room temperature</b>	RT 10 not detected during commissioning. Set	<b>RT 10 equipped?</b> to <b>Yes</b> (see System info on page 26).
Only Service modes are displayed, e.g.: <b>Service 1.A:</b> <b>set maximum central heating heatout</b>	No error: Service mode at heating appliance active.	Press the Service button on the heating appliance.
The following appears each time the button is pressed: <b>◀ press ok to go back</b> <b>Key lock function is active...</b>	Key lock is active.	Deactivate key lock (see Key Lock on page 23).
No display	Heating appliance is switched off.	Switch on heating appliance.
	A "YS Plan" is connected.	No function for TD 200 possible.

Complaint	Cause	Remedy
Required temperature not reached	Thermostat valve(s) in the control room set to low	Fully open the thermostat valve(s) or have an expert replace them with manual valve(s).
	Flow temperature controller on the heating appliance set too low	Set flow temperature controller higher.
	Air lock in the heating system	Vent radiator and heating system.
Required room temperature is greatly exceeded	Installation location of the RT 10 not suitable, e.g. outer wall, proximity to window, draught, ...	Choose a better installation location for RT 10 and have it moved by an expert (see Installation Instructions of the RT 10).
Excessive room temperature fluctuations	Temporary effect of heat from other sources on the room, e.g. from sunshine, room lighting, TV, fireplace etc.	Choose a better installation location for RT 10 and have it moved by an expert (see Installation Instructions of the RT 10).
Temperature rise instead of fall	Time of day incorrectly set	Check setting.
Room temperature too high in Economy mode	Building has high degree of heat storage	Select Economy mode earlier.
Incorrect or no control	Bus connection defective for the devices using the bus	Have the bus connection checked and, if necessary, rectified by an expert according to the connection diagram.
Only Automatic mode can be set	Operating switch defective	Have TD 200 replaced by a professional.

# 11 Settings

The factory settings, setting range and personal settings are summarised here.

## 11.1 MAIN MENU-Settings

MAIN MENU	Factory setting	Setting range	Personal settings
Holiday > Start	--:--:--	Today ... 12.31.2099 (in year/month/day increments)	
Holiday > End	--:--:--	Start date ... 12.31.2099 (in year/month/day increments)	
Holiday > Heating level	Low <sup>1)</sup> Off <sup>2)</sup>	Low / Frost / High <sup>1)</sup> Off / On <sup>2)</sup>	
Holiday > Domest. hot water	Off	Off / On	
Heating > Program	see table on page 32		
Heating > Heating level > High <sup>1)</sup>	20.0°C	5.0°C ... 30°C (not lower than Low; in 0.5-K increments)	°C
Heating > Heating level > Low <sup>1)</sup>	16.0°C	5.0°C ... 30°C (not lower than Frost and not higher than High; in 0.5-K increments)	°C
Heating > Heating level > Frost <sup>1)</sup>	7.0°C	5.0°C ... 30°C (not higher than Low; in 0.5-K increments)	°C
Heating > Optimum Start <sup>1)</sup>	Off	Off / On	
Domestic Hot Water > Program	see table on page 33		
Domestic Hot Water > Circ. pump runs	4/h	0/h ... 7/h (in 1/h increments)	
General Settings > Time and Date > Time	current time	current time (in hour/minute increments and am/pm)	
General Settings > Time and Date > Date	current date	current date (in year/month/day increments)	
General Settings > Time and Date > Summer-/Wintertime	Yes	Yes / No	
General Settings > Time and Date > Time adjustment	0,0 s/week	-60 s/week ... +60 s/week (in 0.5 s/week increments)	s/week
General Settings > Display Format > Time	24 h	12h am/pm or 24h	
General Settings > Display Format > Date	DD.MM.YYYY	MM.DD.YYYY or DD.MM.YYYY	
General Settings > Display Format > Temperature	°C	°C / °F	
General Settings > Display Format > LCD contrast	corresponding to factory test	25% ... 75%	%
General Settings > Key Lock	Off	Off / On	

1) Heating with RT 10

2) Heating without RT 10

## 11.2 EXPERT SETTINGS-Settings

EXPERT SETTINGS	Display example	Factory setting	Setting range	Setting by an expert
System errors	01.01.2005 05 Pump motor (current fault)	-	-	-
	09.25.2004 14 Temp. Sensor (up to max. 9 previous faults)	-	-	-
Maintenance > Next maintenance	22.10.2005	-	-	-
Maintenance > Interval	12 months	0 months (= Function off)	0...120 months	months
Maintenance > Confirmation maintenance	Yes	No	Yes / No	
Service address > Telephone number	012345 6789	-	max. 20 characters	
Service address > Name	ABCD	-	max. 20 characters	
System info > Installation date	22.10.2005	Activation on commissioning	-	-
System info > Type number	TD 200 7 777 777 777	Fixed value ex works	-	-
System info > Software version	JF11.12	Fixed value ex works	-	-
System info > Manufacturing date	27.06.2005	Fixed value ex works	-	-
System info > RT 10 equipped?	Yes	No	Yes / No (is automatically set to Yes on commis- sioning with RT 10)	

## 11.3 Time Programs

### 11.3.1 Heating Program

			P1		P2		P3		P4		P5		P6	
			°C	t	°C	t	°C	t	°C	t	°C	t	°C	t
Factory setting	with RT 10	Mo - Fr	20	06:30	16	08:30	20	16:30	7	22:30	-	-	-	-
		Sa - Su	20	07:00	16	09:00	20	16:00	7	23:00	-	-	-	-
		All days	-	-	-	-	-	-	-	-	-	-	-	-
	without RT 10	Mo - Fr	On	06:30	Off	08:30	On	16:30	Off	22:30	-	-	-	-
		Sa - Su	On	07:00	Off	09:00	On	16:00	Off	23:00	-	-	-	-
		All days	-	-	-	-	-	-	-	-	-	-	-	-
Personal settings	Mo - Fr													
	Sa - Su													
	All days													
	Monday													
	Tuesday													
	Wednesday													
	Thursday													
	Friday													
	Saturday													
Sunday														

Factory settings with RT 10 in the Menu

**Heating levels:**

20°C =  **High**

16°C =  **Low**

7°C =  **Frost**



Switching points P5 and P6 can be defined by the user in addition to the other settings as required.



## 11.3.2 Domestic Hot Water Program

		P1		P2		P3		P4		P5		P6	
		°C	t	°C	t	°C	t	°C	t	°C	t	°C	t
Factory setting	<b>Mo - Fr</b>	On	06:30	Off	08:30	On	16:30	Off	22:30	-	-	-	-
	<b>Sa - Su</b>	On	07:00	Off	09:00	On	16:00	Off	23:00	-	-	-	-
	<b>All days</b>	-	-	-	-	-	-	-	-	-	-	-	-
Personal settings	<b>Mo - Fr</b>												
	<b>Sa - Su</b>												
	<b>All days</b>												
	<b>Monday</b>												
	<b>Tuesday</b>												
	<b>Wednesday</b>												
	<b>Thursday</b>												
	<b>Friday</b>												
	<b>Saturday</b>												
<b>Sunday</b>													



Switching points P5 and P6 can be defined by the user in addition to the other settings as required.

---

# Index

## A

Accessories .....5

## B

Battery power reserve .....5

## C

Changing format for date ..... 23

Changing format for temperature ..... 23

Changing format for time ..... 23

Changing LCD contrast ..... 23

Changing the operating mode ..... 14

- Automatic mode (default setting) ..... 14

- Continuous frost protection ..... 14

- Continuous heating ..... 14

- Continuous low mode ..... 14

## D

Deactivating the lock for the key functions ..... 23

Delete settings ..... 17

## E

Electrical connections ..... 10

- TD 200 in the heating appliance ..... 10

- TD 200 on the wall ..... 10

Expert settings ..... 25

- Maintenance ..... 25

- Operating instructions in brief ..... 25

- Overview ..... 25

- Service address ..... 25

- System errors ..... 25

- System info ..... 26

## G

Greenwich time format ..... 23

## H

Heating appliance (settings) ..... 20

## I

Installation ..... 7

- Assembly ..... 7

## L

Locking the key functions .....23

## M

Main menu ..... 18

- Domestic hot water ..... 22

- General settings ..... 23

- Heating ..... 20

- Holiday ..... 19

- Operating instructions in brief ..... 19

- Overview ..... 18

## N

Notes on saving energy .....27

## O

Operation ..... 11

- Change room temperature and  
operating mode ..... 13

- Elements and symbols ..... 11

- Use menu ..... 15

    Call up Main Menu ..... 15

    End programming ..... 16

    Select submenu ..... 15

    Set values ..... 16

## R

Reset factory settings ..... 17

- Reset a program ..... 17

- Reset all settings ..... 17

Room temperature controller

(see heating program) ..... 14, 20, 22

---

**S**

Safety precautions ..... 4

Service display ..... 26

Setting a corrective factor for time ..... 23

Setting summer-/wintertime ..... 23

Settings

- Expert settings ..... 31
- Main Menu ..... 30
- Time programs (tables)..... 32
  - Domestic hot water program ..... 33
  - Heating program ..... 32

Specifications for room temperature controller

- Accessories ..... 5
- Standard package ..... 5
- Technical data ..... 5

Standard package ..... 5

Summary of factory settings, setting ranges and personal settings ..... 30

**T**

Technical data ..... 5

Trouble shooting ..... 28

**V**

Various system information - info ..... 24

# INSTALLATION, USER INSTRUCTIONS & CUSTOMER CARE GUIDE

Worcester, Bosch Group  
Cotswold Way, Warndon, Worcester WR4 9SW.  
Tel. 01905 754624 Fax. 01905 754619

[www.worcester-bosch.co.uk](http://www.worcester-bosch.co.uk)

**Worcester Bosch Group is a trading name of  
BBT Thermotechnology UK Ltd.**

**6 720 612 220 (05/09) OSW**



067206122202



**WORCESTER**  
Bosch Group

The logo features a stylized, wavy graphic element above the word 'WORCESTER' in a bold, sans-serif font. Below 'WORCESTER' is the text 'Bosch Group' in a smaller, regular sans-serif font.